



Prévenir les désordres,  
améliorer la qualité  
de la construction

PÔLE PRÉVENTION  
CONSTRUCTION

MÉMO CHANTIER®

FONDATEMENTS ET INFRASTRUCTURES

# MISE EN ŒUVRE DES ARMATURES

**RECOUVREMENT**

CHAÎNAGE

BALCON

**NF DTU**

RAIDISSEUR

POUTRE

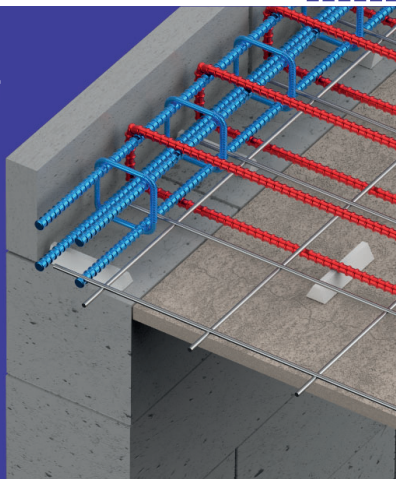

## CONFORMITÉ AU PLAN



## ANCRAGE

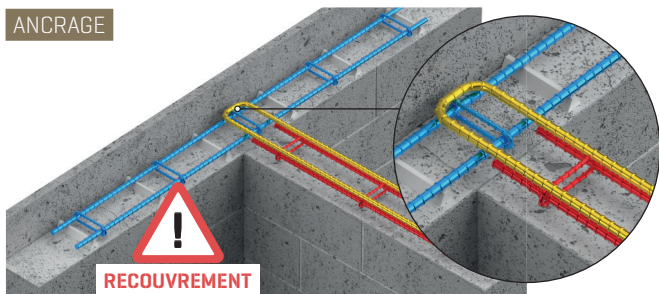

## CALAGE VERTICAL

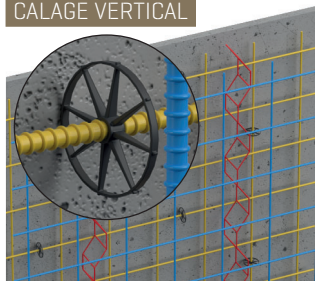

## RECOUVREMENT

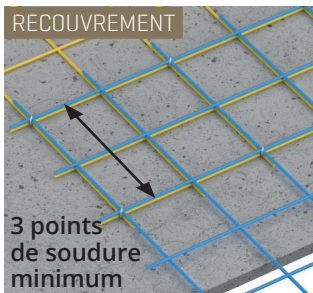

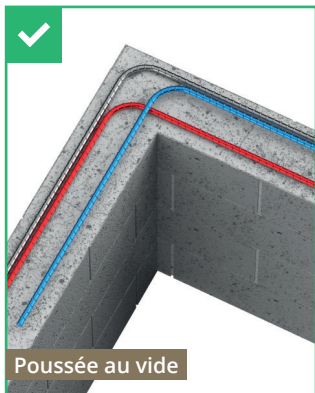

2

## LES FONDATIONS

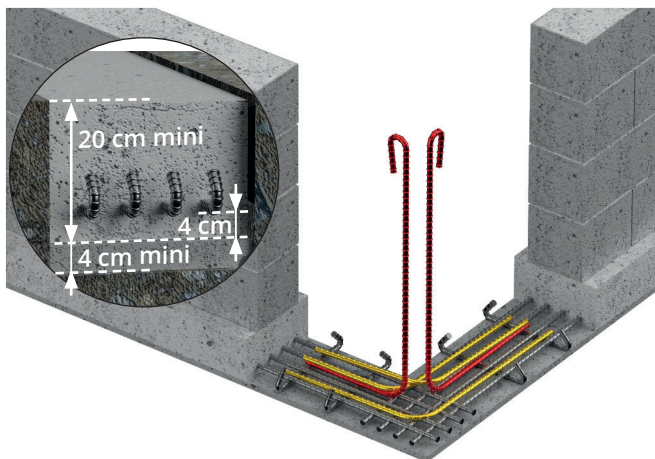

3

## LE DALLAGE

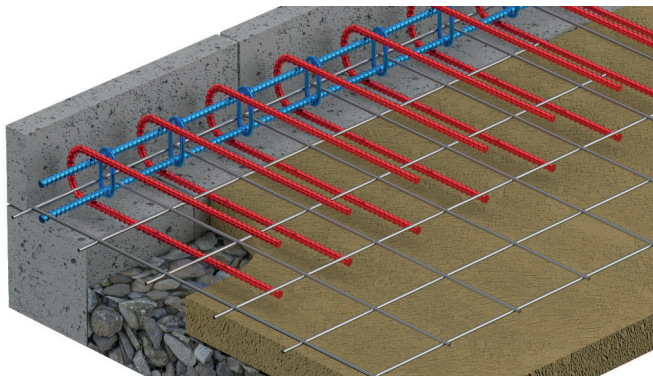

4

## LES PLANCHERS

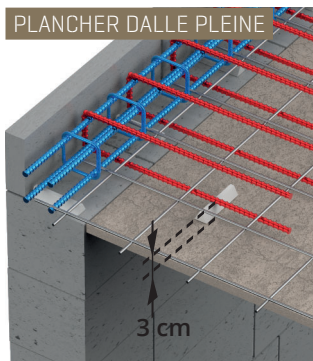
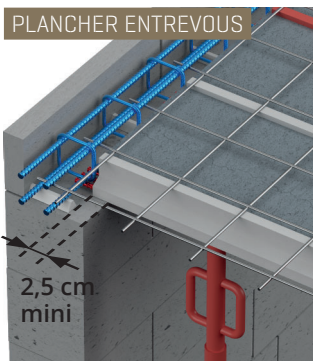

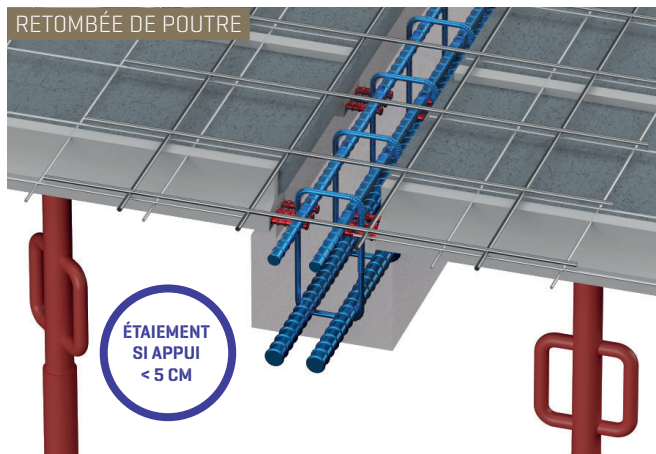
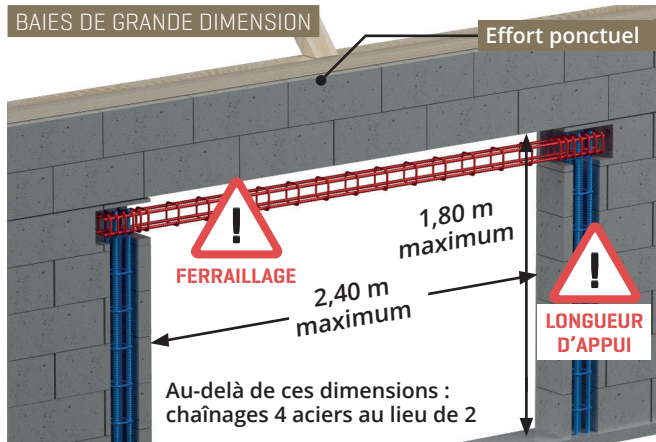

BALCONS

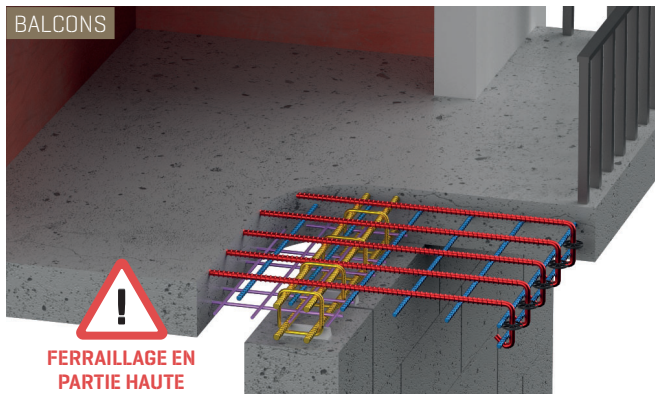

**FERRAILLAGE EN  
PARTIE HAUTE**

TRÉMIES ET CHEVÊTRES

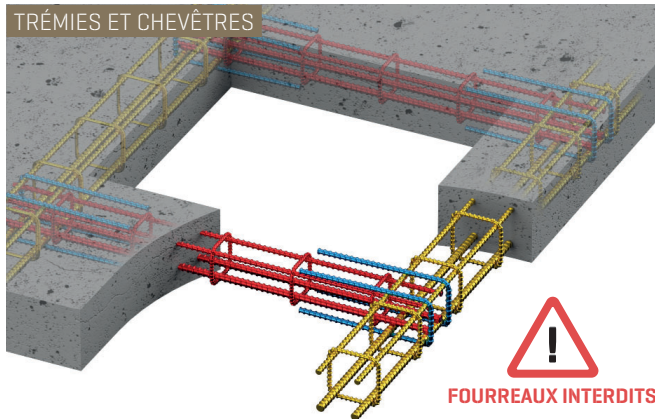

**FOURREAUX INTERDITS**



7

# LES RAMPANTS

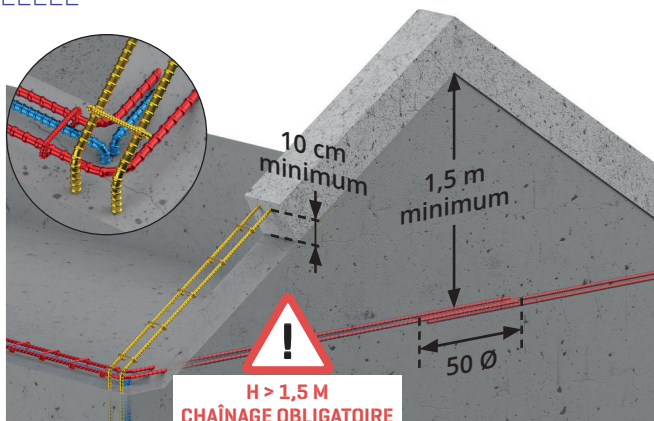

8

# LA LIAISON SEMELLE-POTEAU

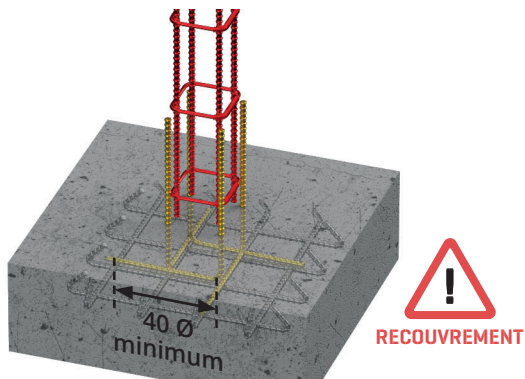

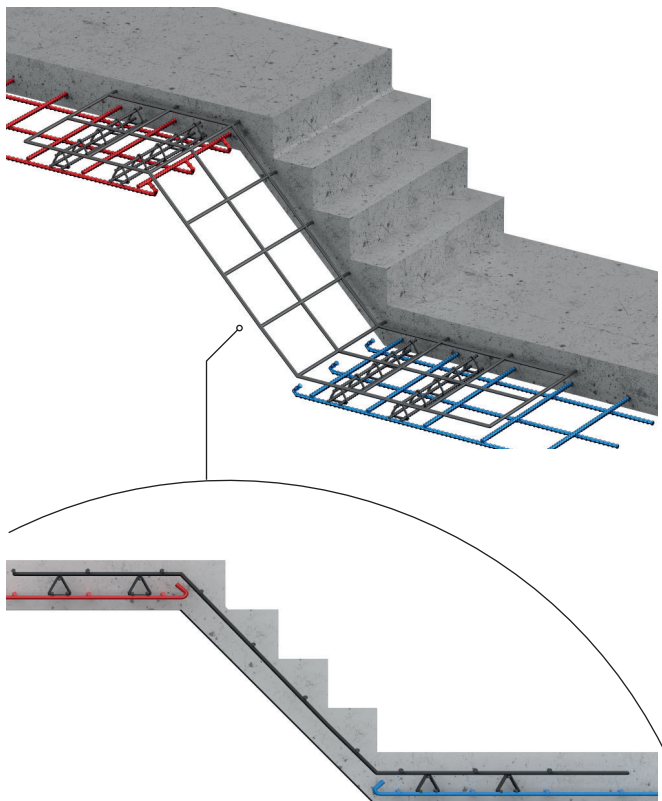

\* Selon le NF DTU 21